

Authors: Prof. Eberhard Ambos, Otto von Guericke University of Magdeburg, Dr. Oliver Brunke and Dr. Dirk Neuber, GE Sensing & Technologies GmbH, Wunstorf, Holger Lux and Dr. Ingo Stuke, GE Sensing & Inspection Technologies GmbH, Ahrensburg, Wolfgang Besser, Druckguss Heidenau, Dohna/Dresden, Mike Ziesemann, Druckguss Hoym, Stadt Seeland/OT Hoym, Prof. Christian Heikel and Andrea Huxol, Polytechnic of Ostwestfalen-Lippe, Lemgo

High-speed computer tomography employed in pressure die casting

A remarkable leap in technology

The continuous efforts – especially undertaken by companies of the automotive industry – to cut down on fuel consumption and as a result reduce the environmental footprint have a clearly perceptible effect also on die castings made of aluminium alloys.

While retaining more or less the same dimensions, numerous components have become lighter as a result of smaller wall thicknesses. The design solutions of these components differ strikingly from those of former component generations. Other components have become larger in dimensions and technologically more complex due to increasing functional integration and the deliberate avoidance of joining or assembling activities. Hydraulic or pneumatic elements, which used to be arranged outside the components, are to an increasing extent being integrated into them. As a result of this, the integral components often contain geometric elements of very small dimensions. Material strength specifications, especially dynamic strength properties, also become increasingly more exacting.

Among the customers of die casting shops, awareness has been growing that when using die cast components the focus should not only be on the advantages of an effective manufacturing process. An eye should also be kept on the less favourable aspects, for example the unavoidable inclusion of gases as a result of the employment of gas-tight moulding materials. However, for the engineer it is important to get clear information about the locations of po-



Industrial (left) versus medical CT unit (Photos: General Electric)

rosity in the casting. Generally, pores are acceptable at locations where the strain condition is insignificant or when gas and pressure tightness does not matter. This, however, makes exact knowledge of the characteristics of the porosity, i.e. location, volume and size of the pores, indispensable. Numerous efforts have been made to develop progressive calculation procedures for highly stressed Al pressure die castings that take into account the existence of defects in the castings [1-4]. At the same time, requirements on the precision of the castings, i.e. dimensions

and shape of the functional elements, are becoming increasingly exacting.

Irrespective of these technological aspects, customers of die casting shops are extremely demanding as far as manufacturing dynamics and delivery performance of their suppliers are concerned. The time from pattern development to series production of a casting must be minimized. Immediate, quality-improving reactions are expected whenever there are any shortcomings in the manufacturing process. All these factors have consequences among others for the testing

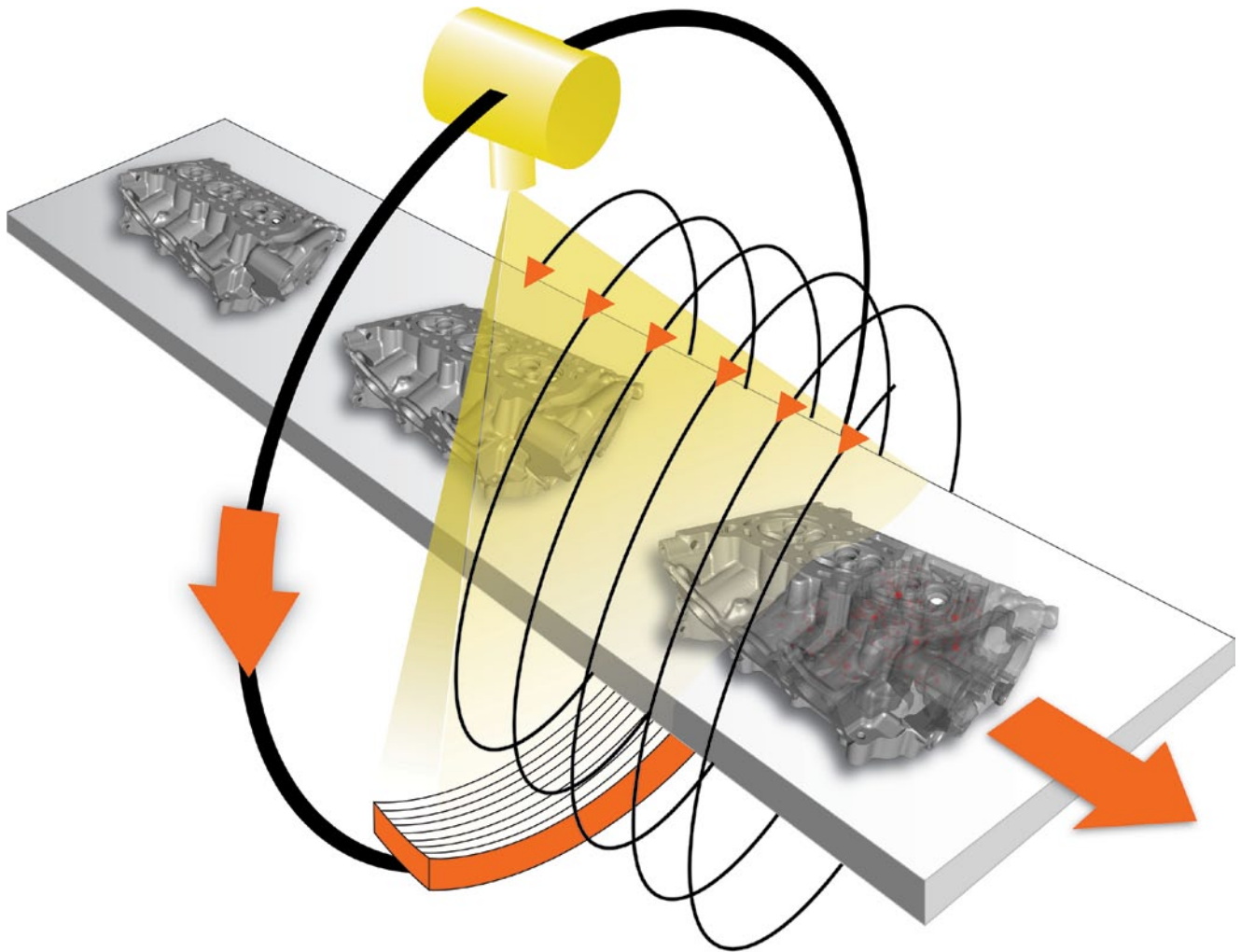

Figure 1: In a high-speed, automatic helix in-line CT unit the gantry, which accommodates the x-ray tube and the multi-line detector arranged opposite, rotates about the specimens on the conveyor belt [6]

equipment used in die casting shops in the future. This article presents results and experience gained from the world's first application of high-speed computer tomography (CT) in pressure die casting and in the preparation of a specific case of series production.

Development of high-speed computer tomography systems

Triggered by the increasingly more exacting demands of companies in the automotive industry, there has been growing interest in the development of new non-destructive testing techniques. The commonly used 2-D x-ray testing method is not suitable to provide rapidly enough a sufficient quantity of information about the complete casting. Due to the fact that for a rather high capital investment and high operating costs involved the user only gets a fairly low sample through-put rate, con-

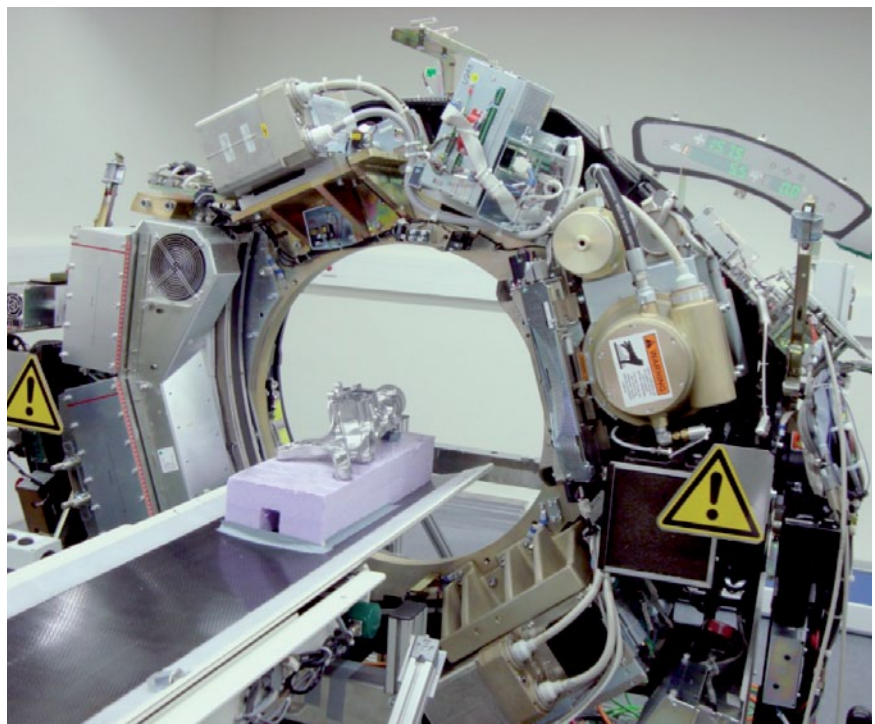

Figure 2. Laboratory-scale high-speed CT scanning a die casting

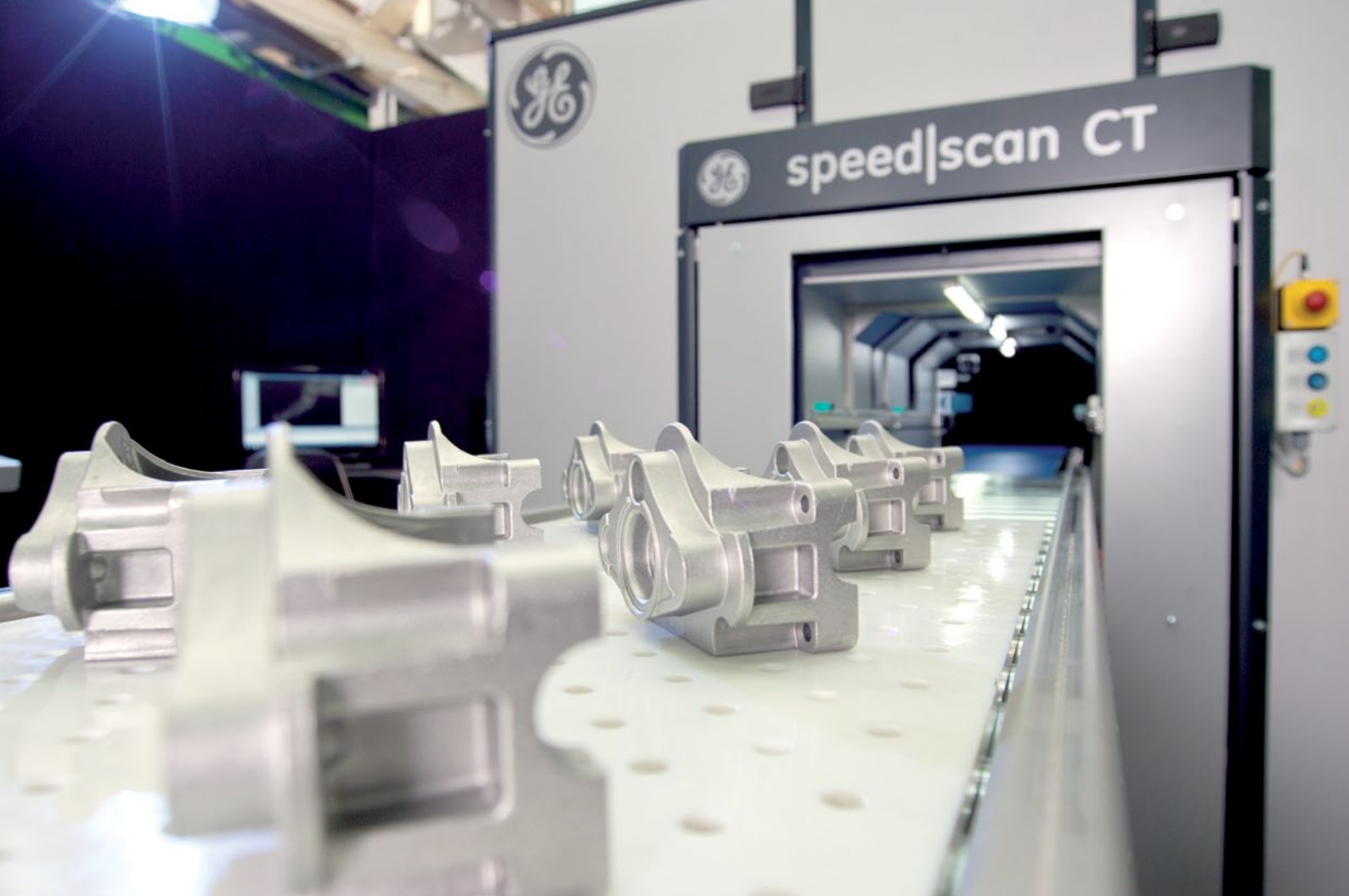

Figure 3: Series-type high-speed CT unit

ventional industrial computer tomography systems have so far only been used by large foundries operated by carmakers. Most recently, these factors have led renowned suppliers of x-ray inspection systems to realize the advantages of medical computer tomography also for industrial applications and they have systematically implemented this technology in equipment for non-destructive material testing.

The charm of this development is that the scanning rate can be several hundred times higher than that of conventional CT systems, markedly reducing the time needed for a scan.

According to [5], all current CT systems for medical applications operate in a helical mode, with the object to be scanned moving along its longitudinal axis through the radiation plane and the gantry assembly rotating at a constant angular velocity. Depending on the instrument type, several axial planes can be captured at the same time (multi-plane or multi-line helix CT). This makes the process faster and reduces artifacts of movement.

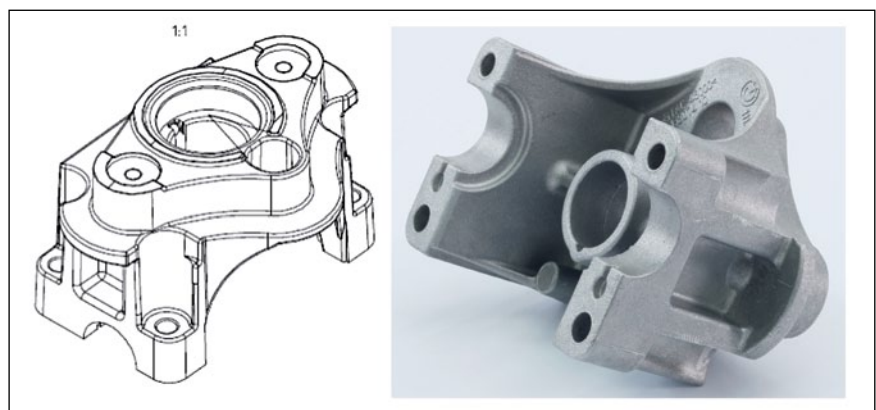

Figure 4: The scanned aluminium die casting

As illustrated in **Figure 1**, the gantry assembly (scanning unit), which accommodates the x-ray tube, rotates about the casting to be tested, while a conveyor belt is moving the casting through the gantry at low speed.

Results of tests of real parts and performed under production conditions

The past twelve months have seen intensive studies verifying the suitability of high-speed CT for the testing of

die cast parts. The studies were conducted by General Electric (GE) Sensing & Technologies GmbH, Wunstorf, General Electric (GE) Sensing & Inspection Technologies GmbH, Ahrensburg, and Druckguss Hoym GmbH, Stadt Seeland/OT Hoym, all Germany, in cooperation with several automobile producers. Whereas initially a laboratory-scale unit (**Figure 2**) was used, as the examinations proceeded, the industrial-scale unit developed by GE (**Figure 3**) in parallel to the studies was

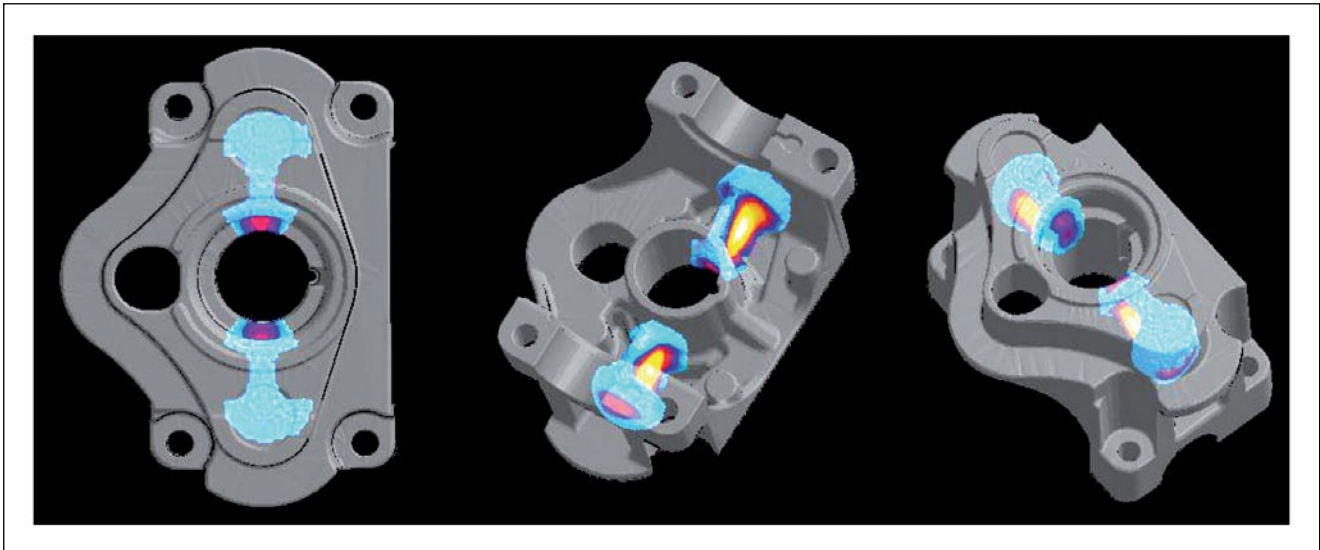

Figure 5: Simulation of the test piece for hot spot identification in different planes of the part (forecast locations of volume deficits due to shrinkage; colour scale: turquoise approx. after 18 s, light red after approx. 20 s, yellow after approx. 21 s)

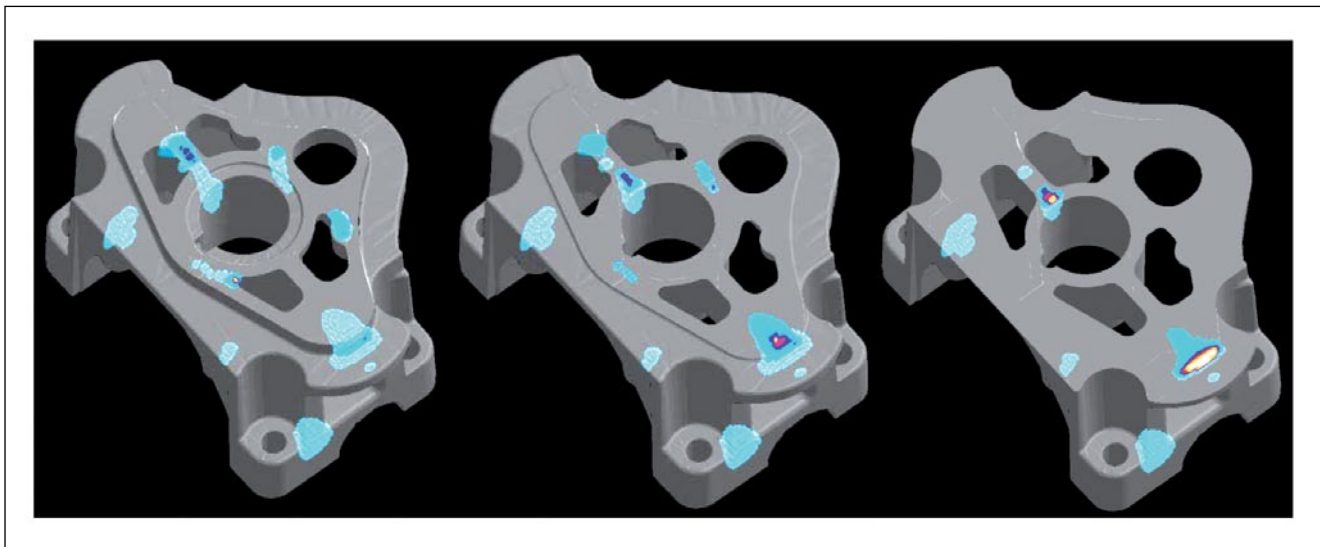

Figure 6: Simulation of the test piece visualizing porosity in different planes of the part (red: probability of pore formation approx. 50 %, yellow: 75 to 85 % and white 100 %)

being increasingly used for the tests. The technical data of the latter are as follows:

- » Maximum size of test of the pieces: approx. 400 mm x 300 mm x 800 mm (W x H x L),
- » high-capacity x-ray tube with max. 140 kV, 380 mA current, in continuous operation max. 140 kV, 25 mA current,
- » max. generator power 53 kW at 440 mA,
- » typical scanning rates from 5 to 10 mm/s,

- » reconstruction rate: > 16 planes/s,
- » 16-channel data acquisition for high specimen through-put rate,
- » typical detail resolution or voxel size (XY): approx. 0.2 to 1.0 mm, depending on the size of the reconstruction area.

Below, we will describe the examination procedures and results of the examinations by way of example of a cast part for a renowned German carmaker – a pedestal for an oil pump (**Figure 4**). These castings must comply with spe-

cial requirements in terms of oil tightness.

Comparison of simulation results versus tomograms

In the initial phase of the examinations, which involved the testing of the first high-speed industrial-scale CT system, a major point was to compare the simulation of the casting, generated by a well established simulation programme [8], with the tomograms of the cast parts. **Figures 5** and **6** show the simulation result. Visible are volume def-

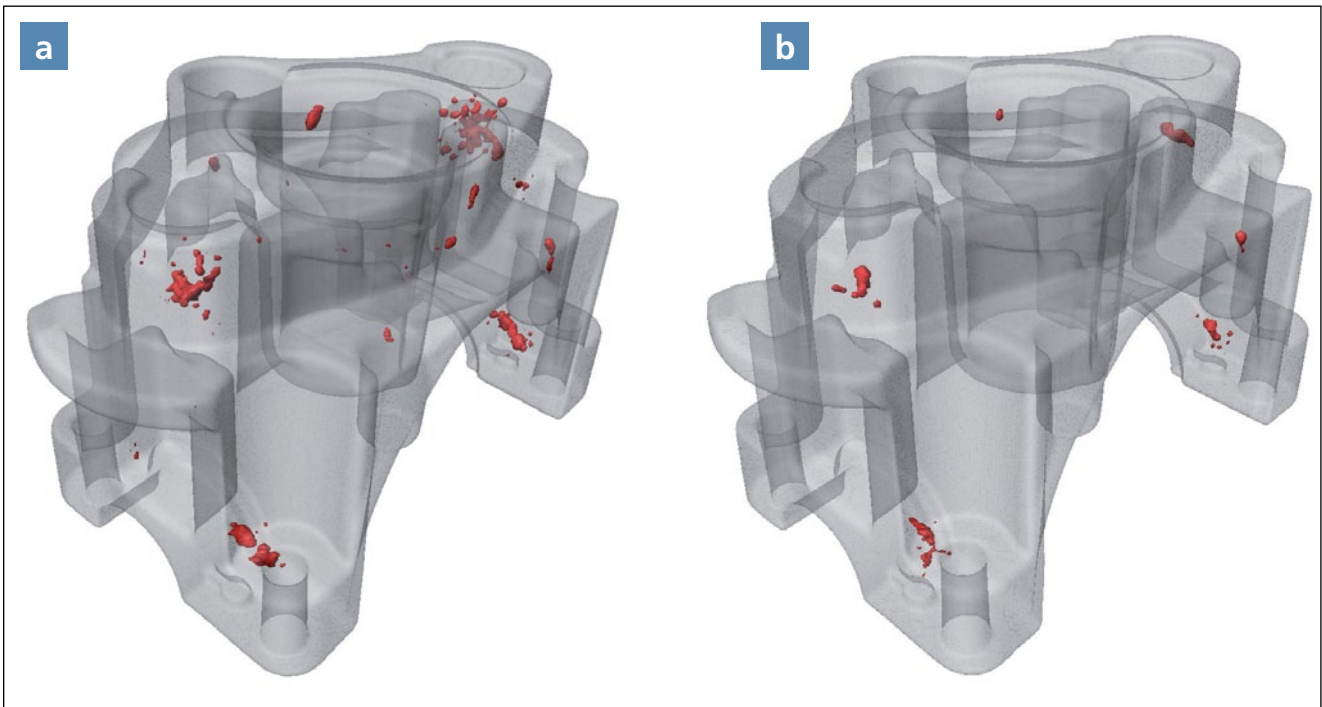

Figure 7: Transparent 3-D model of the test pieces: a) with the highest degree of porosity (part No. 4) and b) with the lowest degree of porosity (part No. 10)

icits due to shrinkage as well as pores and their positions within the casting.

Based on the simulation, the die caster can make a first assessment as to whether or not the positions and the likely dimensions of the volume deficits fall within the specifications of the castings. However, the exact positions of the pores in the casting as well as their volume and the exact size distribution of the pores are not visible in the simulation images.

Here, high-speed computer tomography can be an excellent method to enhance the simulation of porosity in castings. For this purpose, forces were joined with the developers of the simulation software, which is a renowned company in this field. The tomograms tell the designers and computation engineers in the automotive industry the exact positions and exact volumes of the pores. From this information, they can derive conclusions as to the strength-related specifications of the cast parts (**Figure 7**). In the first die casting shop to use the high-speed CT unit, the idea was born to build up a generalized data base of scanned die castings complete with all related technological data and

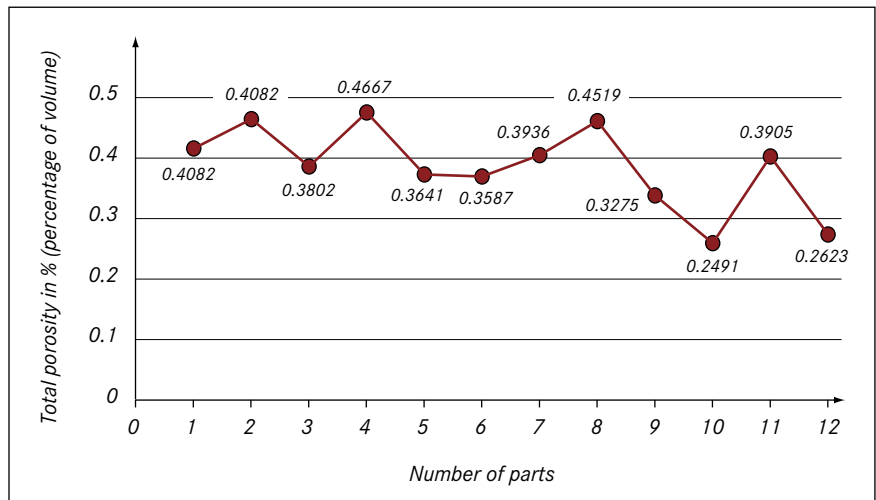

Figure 8: Total porosity relative to number of parts

manufacturing parameters. This will enable the component designers to cooperate with the foundry technologists at a very early stage of the development process, taking advantage of the experience from the manufacture of similar or identical parts. Time-consuming and costly repetitive work can be avoided by falling back on knowledge from previous efforts.

For the tomographic scanning, 120 parts were randomly chosen from stock.

The pore content distribution in these tested parts was between 0.2491 % and 0.4667% (**Figure 8**). Meanwhile, other castings tested in greater number have provided similar values. Considering all tested parts, the detected defect sizes range between 0.75 m³ and 197 m³.

For casters with a deeper interest in technological aspects, the repetition accuracy of the pore volume measurement may be of certain relevance. To

this end, one and the same casting was scanned fifteen times. This provided the following result: The repetition accuracy of defect volume measurements is 0.32 ± 0.03 % for 15 repetitive scans of the same casting.

To validate the volume defects found in the tomograms, the specimens with the highest (part No. 4) and with the lowest porosity (part No. 10) (both shown in Figure 7 as transparent 3-D models) were subjected to metallographic examinations. **Figure 9** shows the result of the metallographic examination of the part with the largest content of porosities detected by the tomographic scan. It is obvious that the positions of the predicted pores and volume deficits due to shrinkage in the tomograms largely correspond to those in the microsections. The images shown in the lower part of the figure are microsections cut through the spatial structure of the volume defects.

As microsections are two-dimensional illustrations, an exact comparison with the complex volumetric structure of the pores and shrink holes is difficult to accomplish. Any – even most minute - deviations in the position of the cut or in the sample preparation may alter the two-dimensional microsection. The imperfections visible in the transparent 3-D model (Figure 7) take the shape of ramified pore accumulations. The dimensional extent can be confirmed by a microscopic examination, but not the exact shape of the defect. Also part No. 10 (see transparent 3D model in Figure 7b), which was found to have the lowest content of detected porosity, was subjected to a metallographic examination. The results are shown in **Figure 10**. The examination confirms the clearly smaller amount of defects compared to the other casting, as was indicated by the transparent 3D model.

In summary it can be concluded from the first comparisons between the tomograms and the metallographic examinations that there is a high degree of correspondence between the positions and dimensions of the detected defects. However, in order to be able to make a conclusive statement about the detection limits of individ-

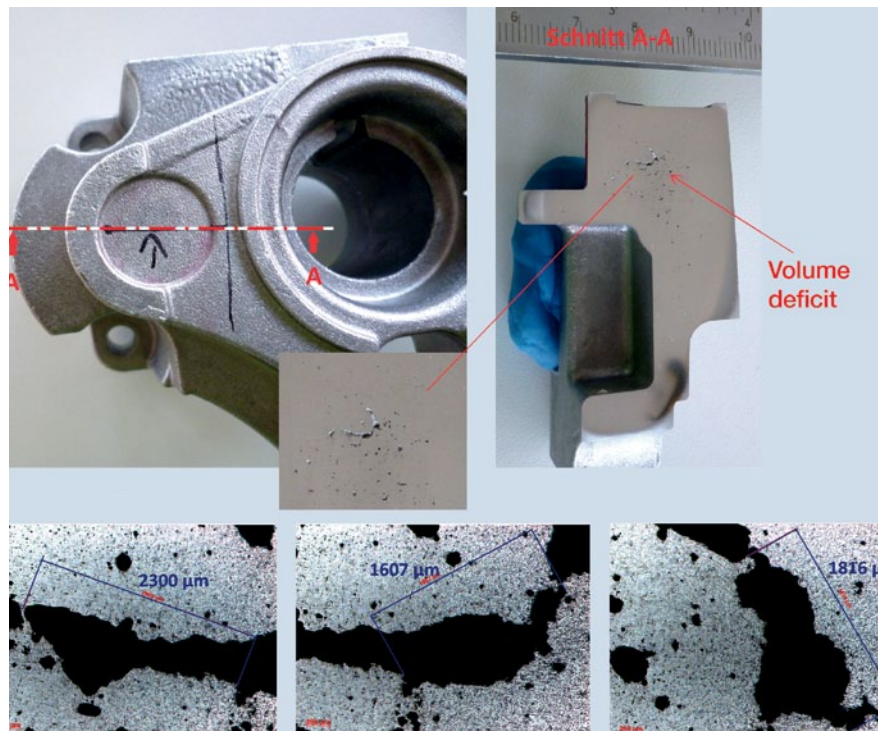

Figure 9: Metallographic examination of part No. 4, the part with the highest porosity in Figure 7a

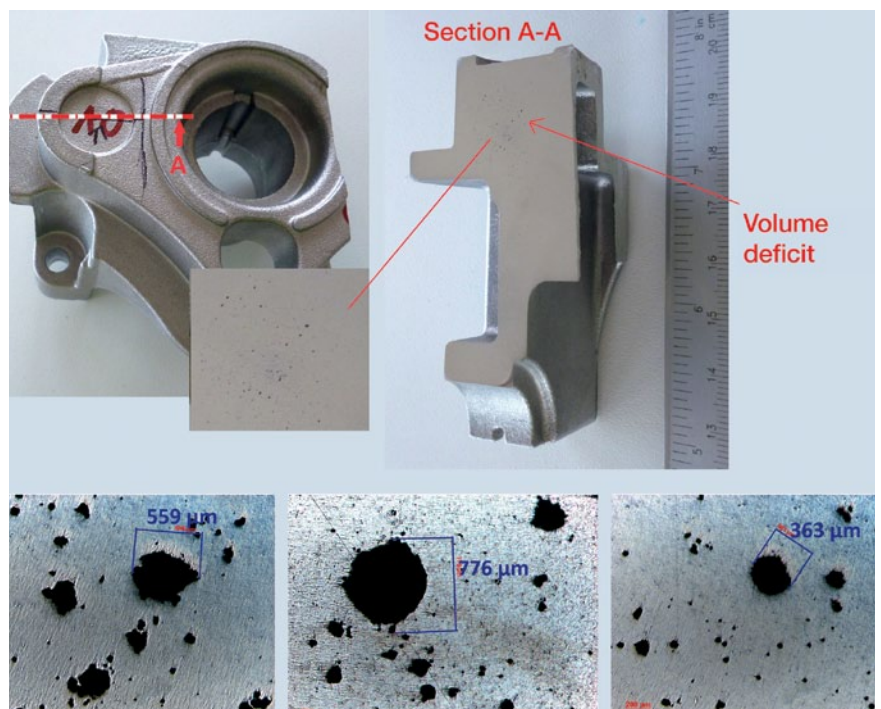

Figure 10: Metallographic examination of part No. 10, the part with the lowest porosity in Figure 7b

ual pores and their minimum dimensions, additional examinations will be necessary, e.g. on defined reference samples with internal microdefects of exactly known dimensions.

Dimensional accuracy of the measurements

Earlier examinations have already shown that modern, high-resolution industrial CT systems attain a measur-

ing precision that is comparable with that of established coordinate measurements. A key feature of CT scanning is that all surface points are captured simultaneously - including all hidden undercuts, which cannot be captured by other non-destructive measuring methods [9-11]. In order to also gain knowledge as to whether the newly developed, high-speed CT system, which is based on medical helix computer tomographers, would be suitable to perform dimensional measurements of specimens (in addition to the detection of porosities in castings), comparative measurements were made of test casting No. 5. The CT measurement results were compared, on the one hand, with exact touch probe measurements and, on the other hand, with the results of fringe pattern projections. Use was made of surface data captured by the Atos fringe pattern projection system developed by GOM, Braunschweig, Germany.

For assessing the measuring accuracy, the company which had developed and manufactured the high-speed CT system made measurements with a special touch probe. The touch probe is an 80-mm-diameter carbon fibre tube of 500 mm length. It is fitted with 40, extremely precisely ground corundum balls. Comparison of the tactile measurement with the tomographic measurement reveals a very high accuracy of $\pm 10 \mu\text{m}$ for the CT measurement.

Likewise, a high degree of correspondence was found between the CT data and the fringe projection data (Figure 11): absolute deviations of the surface data are in the $< \pm 100 \mu\text{m}$ range for 67% (1 sigma) of the points. Greater deviations are predominantly found in areas which are “difficult to access” for the fringe projection measurement.

Figure 12 shows a 2D section with a comparison of measurement results for a nominal distance of 91.000 mm. The GOM system measured 90.910 mm, the speed|scan CT 90.865 mm. Hence, the absolute deviation between the fringe projection measurements and the CT data for this dimension is 0.045 mm. Based on 15 measurements of casting No. 5, the spread of the CT data is $\pm 10 \mu\text{m}$ for distance and diameter measurements.

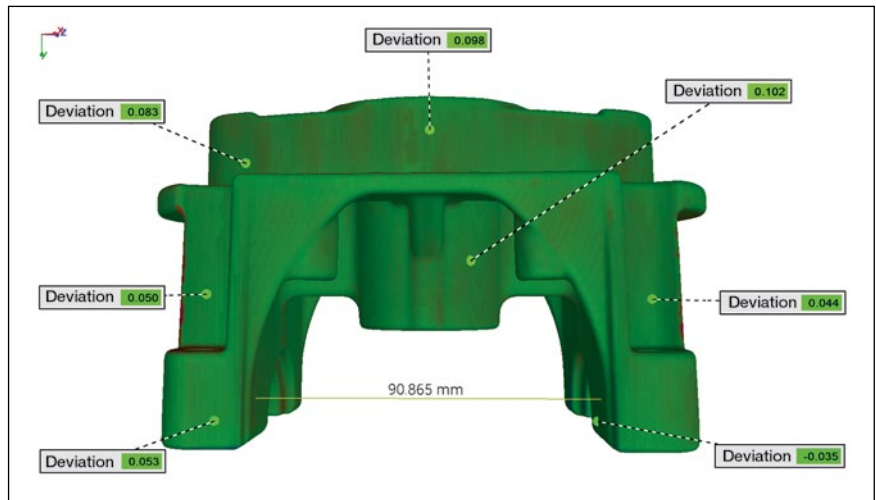

Figure 11: Dimensional deviations of the tomograms versus the fringe-projection-based measurement of part No. 5

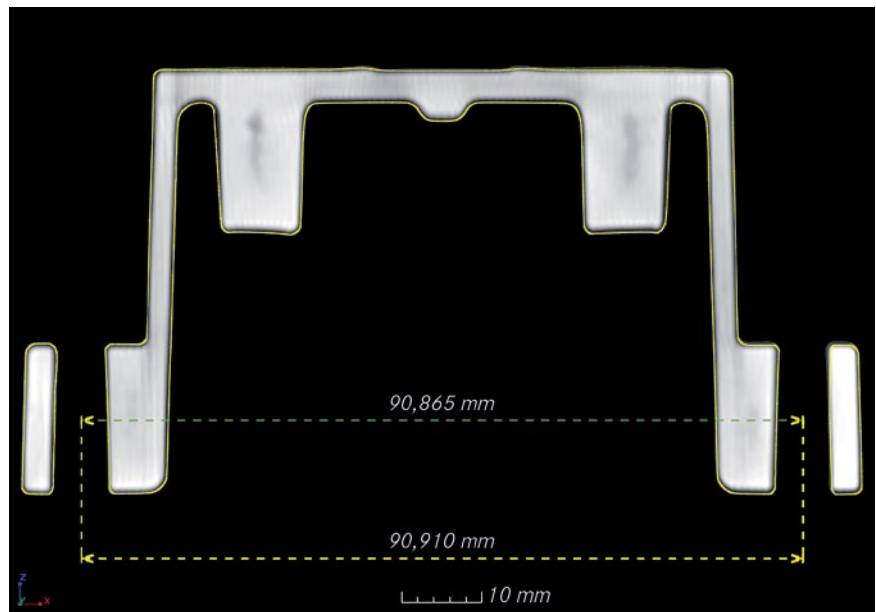

Figure 12: Chosen nominal distance of 91.000 mm measured by high-speed CT and by fringe projection

Integrating the high-speed CT system into the production flow

As to the integration of the newly developed CT system into the production flow, a differentiation is made between two basic variants: the at-line and the in-line arrangement. The at-line arrangement is recommendable primarily to small and medium-size operations, which are characterized by a diversified production portfolio of small and medium series. In this case, the CT unit is set up directly in or near the casting shop.

With the high-speed CT arranged “at the line” (Figure 13), it is possible to scan the complete production programme of the foundry. During the trial phase of a new die or when a previously used die is being “re-started”, the produced castings will be immediately sent to the high-speed CT for scanning. From the evaluation of the tomograms and the assessment of the casting result, conclusions can be derived as to whether it might be necessary to modify the technological process. This procedure will be repeated as

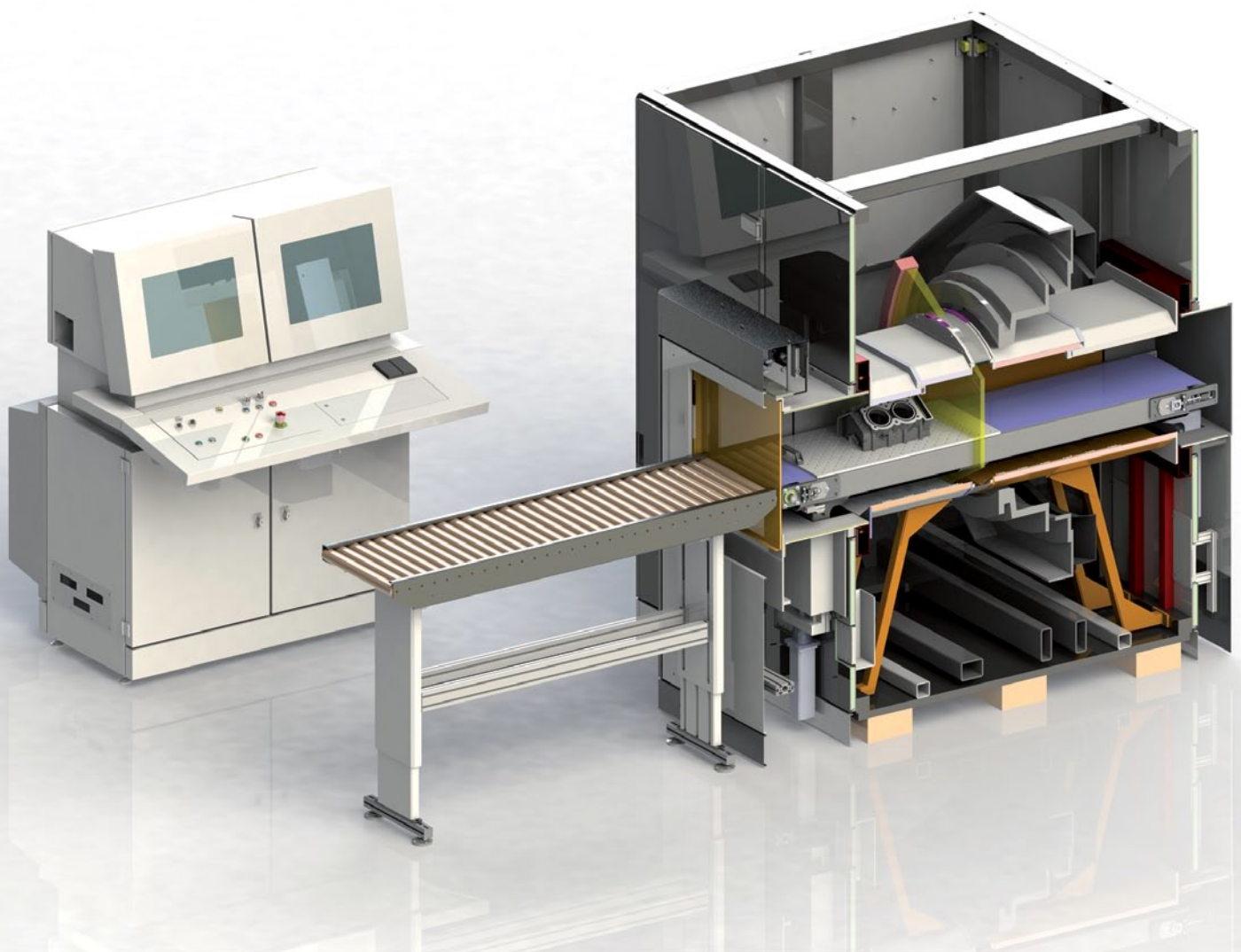

Figure 13: High-speed CT system in at-line arrangement

long as a consistently high quality level of the castings is achieved. This arrangement affords the benefit that the considerably high expenditure on the CT technology is equally spread on all die casting machines and the castings produced with them.

In large-series or mass production, especially when extremely exacting quality requirements must be fulfilled (e.g. castings for the aviation and automotive industries which are subject to mandatory testing), it may be useful to set the high-speed CT unit up in an in-line arrangement (**Figure 14**). In this set-up, the procedure is as follows: Every cast part is transported to the CT by a conveyor belt. Depending on the size of the casting, it takes 10 to 90 s to generate the tomogram. The internal computer compares the tomogram with a “quality standard” of the castings. As a result, castings with acceptable defects are discharged via the conveyor belt without any intervention, whereas out-of-spec castings are sorted out.

This can be done manually upon a signal indicating an out-of-spec casting or automatically by a robot.

The testing procedure is as follows: The industrial “speed|scan atline” CT unit consists of a radiation-proof cabin with an integrated, rotating ring-shaped scanning assembly, the gantry, and the sample transport system that moves the casting through the gantry. The radiation-proof cabin is fitted with a slide gate which opens for the specimens to run into and out of the scanner. The operator will place the specimen on an integrated roller table and feed the part into the system via the gate. Behind the gate, inside the radiation-proof cabin, a conveyor will move the specimen into a pre-scan position. Then the operator will close the gate via a two-handed operation. The scanning process will start automatically after the operator has selected the scanning parameters at the operator panel. When the scan has been completed, the specimen will be automat-

ically discharged via the gate. Here the operator can pick up the scanned specimen and take it to whatever process steps will follow next. The captured volume data of the specimen will be directly transmitted to the visualization and analysis station, where any necessary defectoscopic and metrological examinations will be performed.

For the examinations of the above described cast part, the specimens were placed on the conveyor belt of the CT unit. It took approx. 4 s to transport the parts from there to the working area of the gantry, approx. 23 s to scan them (from the start of the gantry until the parts had completely passed through) and again 4 s to take them back to the original position on the roller table. The 3-D defect evaluation of a part’s tomogram takes approx. 15 s. The cabin complies with the radiation protection requirements as stipulated in the German x-ray regulations (RöV [7]) for a fully protected device. The cabin is rated for x-ray sources with a maximum accelerat-

■ QUALITY ASSURANCE

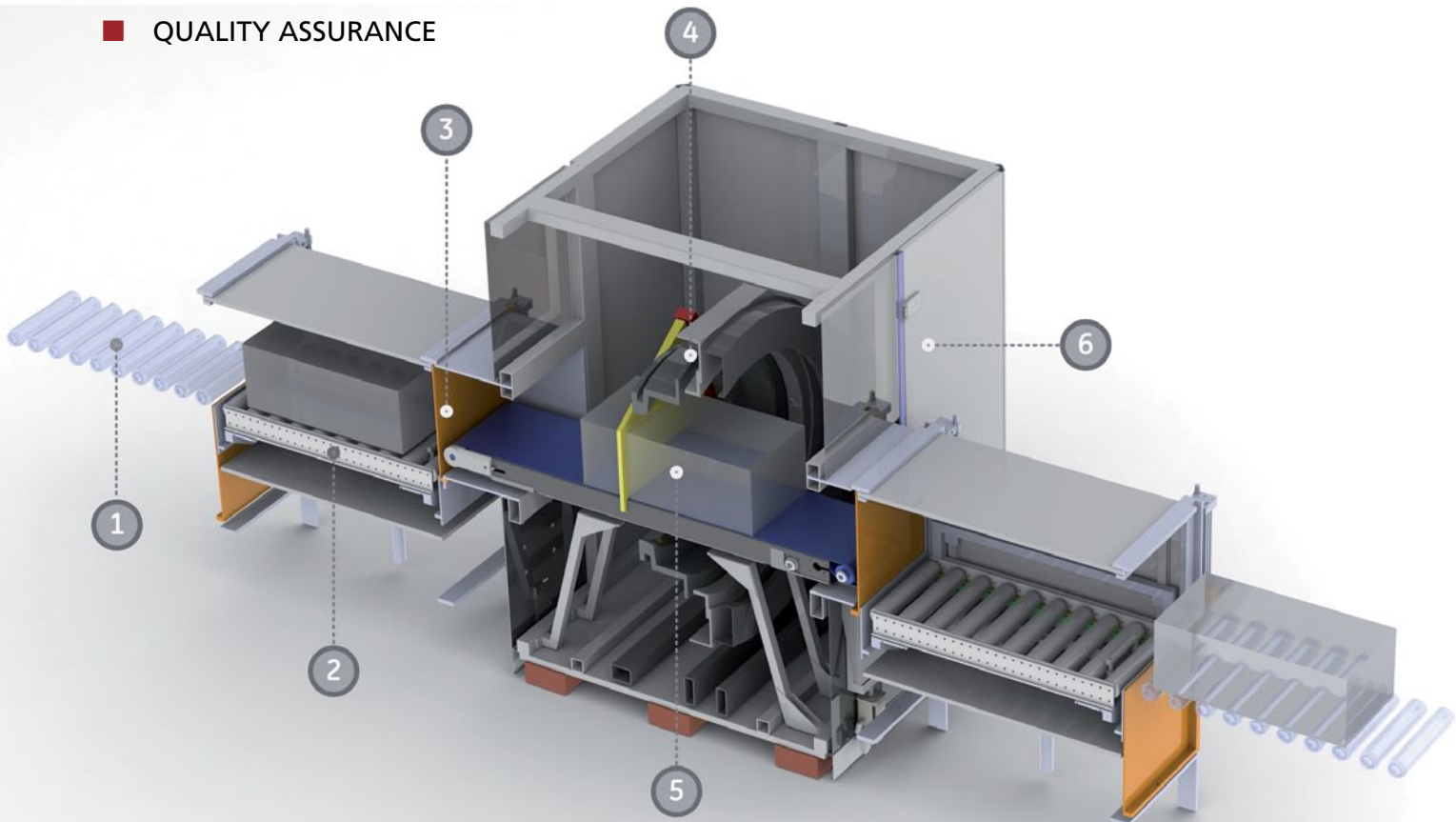

Figure 14: High-speed CT system in in-line arrangement: (1) roller table, (2) roller table with lifting system for level adjustment, (3) slide gates (radiation protection), (4) scanning unit (gantry), (5) specimen, (6) radiation-proof cabin

ing voltage of 140 kV and equipped with a radiation-proof floor. The unit can be easily integrated into industrial production processes. It securely protects the imaging system from dust and other foreign matter. The cabin is fitted with an optimized and active air-conditioning system that effectively extracts the heat generated by the scanning process.

Benefits expected from the use of high-speed CT

The economic effects arising from the use of high-speed CT technology will largely depend on the circumstances in the specific company. This aspect was also part of the examinations. For obvious reasons, in this article we have to limit ourselves to the presentation of qualitative information.

The benefits identified include:

- » streamlining and qualitative enhancement of the simulation process,
- » shorter pattern development process for new die casting dies,
- » faster attainment of quality targets after production with used dies,

- » reduced scrap rate as a result of improved quality control,
- » expansion of the product range by more complex parts (e.g. castings subject to mandatory testing and used in high-stress applications such as aviation and automotive engineering),
- » avoidance of unnecessary machining work.

Summary and future developments

The comprehensive tests with the newly developed, high-speed CT technology using real die cast parts for high-stress applications have shown that these new testing devices are actually mature for use in industrial production and that they perform highly efficiently. Thanks to the exemplary cooperation between the developer and manufacturer of the equipment and a renowned die casting plant, it was possible to achieve the intended performance parameters in a short time.

The partners to this project are convinced that in the near future high-speed CT technology will become part

of the standard equipment available in all die casting shops with a technologically challenging production range.

It is expected that the next few years will see further developments in high-speed computer tomography that are geared, for example, towards an enlargement of the space available to accommodate the specimen. This would make it possible to also non-destructively test larger components (e.g. structural parts for the car body) in the future in an economically efficient way.

The partners intend to pursue this development in further research projects and in cooperation with additional partners, especially with the intention to use high-speed computer tomography to sophisticate strength calculations for aluminium die castings.

References

www.giesserei-verlag.de/cpt/references

www.ge-mcs.com
www.dgheidenau.de